

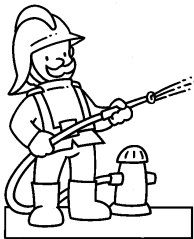

Las Profesiones y los oficios

Todos tenemos un trabajo, el trabajo de los niños es ir al colegio, hacer las tareas, jugar. Los adultos trabajan en distintas profesiones y oficios.

Hombres y mujeres pueden realizar todos los trabajos. Hay doctores, profesoras, carabineros, payasos, bomberos, pescadores, camioneros, pintores y muchos más.



profesiones de emergencia

Los médicos, carabineros y bomberos trabajan para ayudarnos cuando hay emergencias. ¿Sabes a que número cuando los necesitas? Anótalos

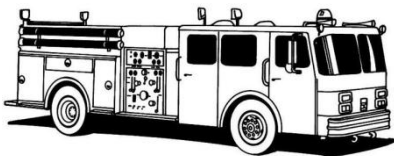



EL DOCTOR

Sana a los enfermos, pone inyecciones, vacunas y receta medicamentos.

Trabaja en hospitales y consultorios. Utiliza termómetros, jeringas, estetoscopios para escuchar el corazón. Completa la mitad que le faltan a los elementos que utiliza el doctor.

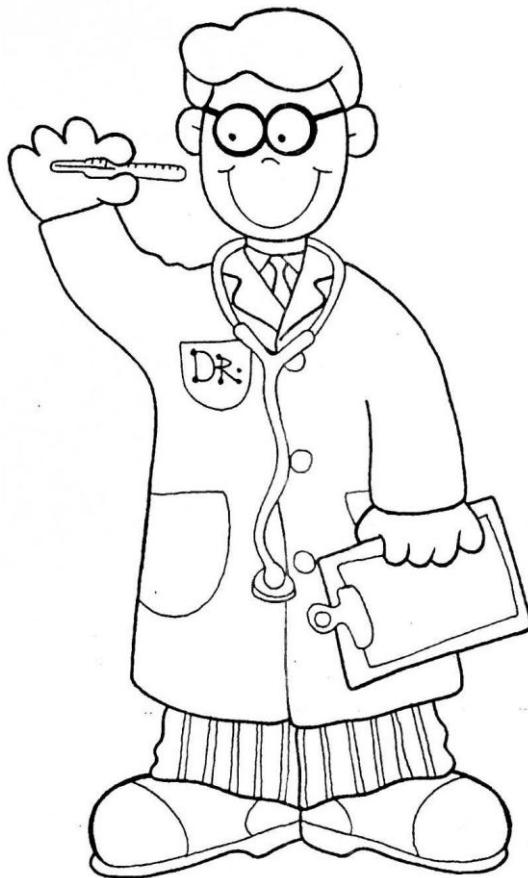

Parche

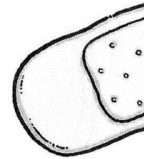

Algodón



Termómetro



Remedios

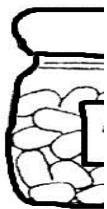

Jeringa

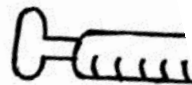



EL BOMBERO

Apaga los incendios y ayuda a las personas y animales en accidentes. Usa la manguera, escalera, botas, casco y saca agua del grifo para apagar los incendios, viaja en un carro de bomberos.

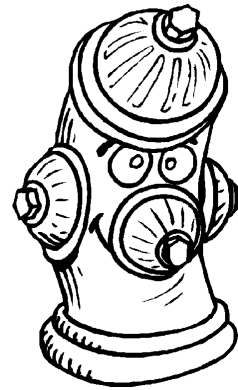

El bombero tiene una manguera larga. Sigue el camino, primero con tu dedo y luego con un lápiz. Luego pinta el bombero

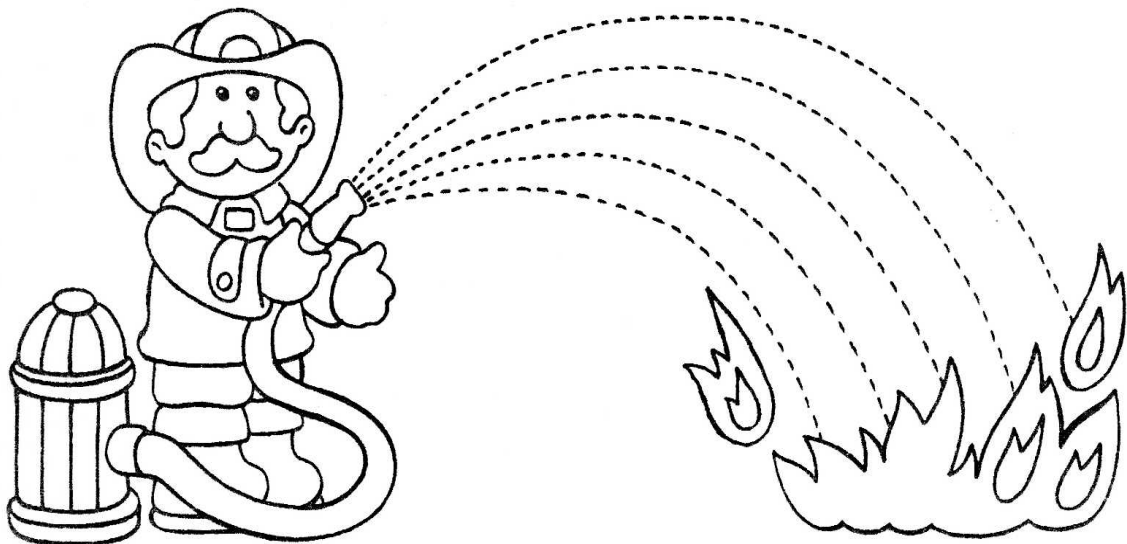



LA CARABINERA

Protege a las personas. Ordena a los autos en las calles y atrapa a los ladrones.
Trabaja en patrullas, motos, caballos y helicópteros.



Puedo llamar al 133 cuando necesito ayuda. Repasa el espiral con mucho cuidado

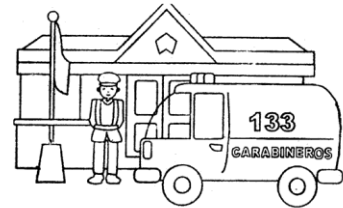
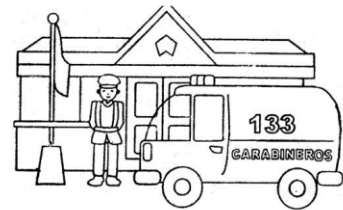



LA PROFESORA

Enseña a los niños, hace tareas, juegos, lee cuentos y canta canciones para los niños. Ella trabaja en la escuela. Usa un delantal, lápices, temperas, pinceles, libros, etc. Dibuja a tu profesora en el cuadro.

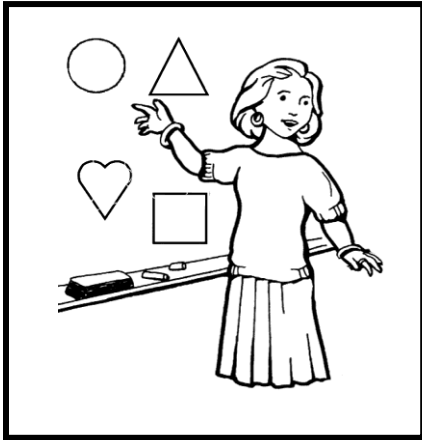

Cuenta los elementos y escribe el número que corresponde:

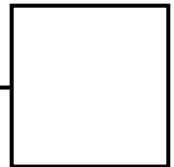
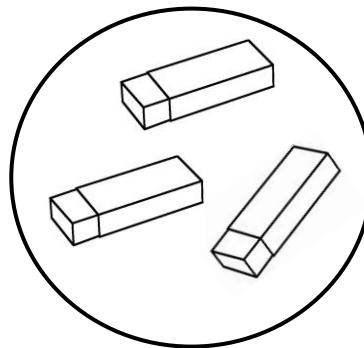
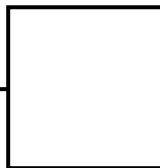
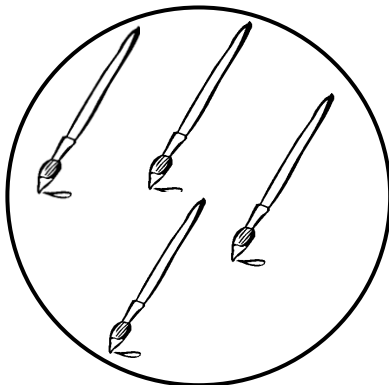
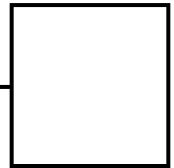
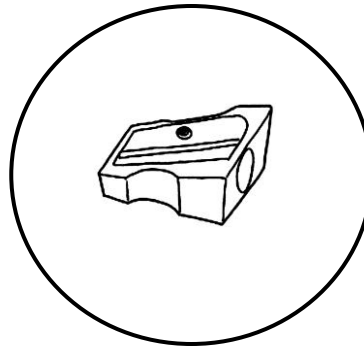
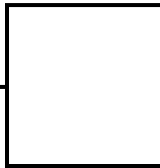
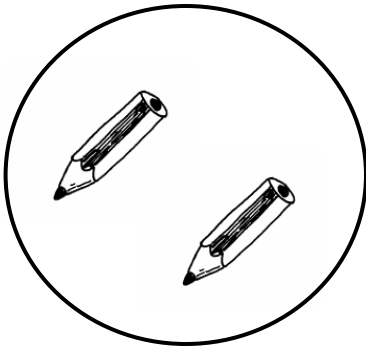



EL MECÁNICO

El mecánico trabaja con los autos y camiones, cambia las ruedas y arregla las luces y los motores de los vehículos. Continúa la trayectoria de cada mecánico para encontrar sus elementos de trabajo.

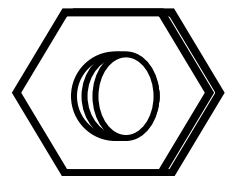
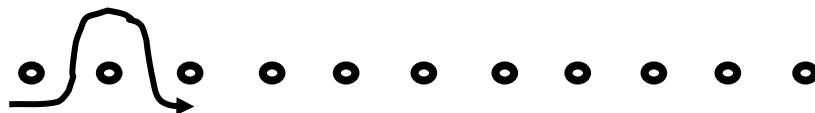
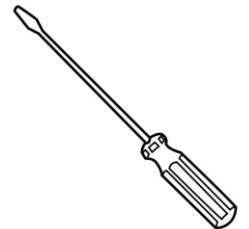
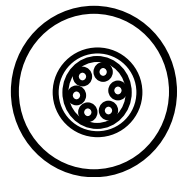



EL MARINERO



Trabaja en los barcos que transportan alimentos y también en los barcos que cuidan nuestro mar. ¿Qué elementos ves? Pinta sólo el salvavidas.

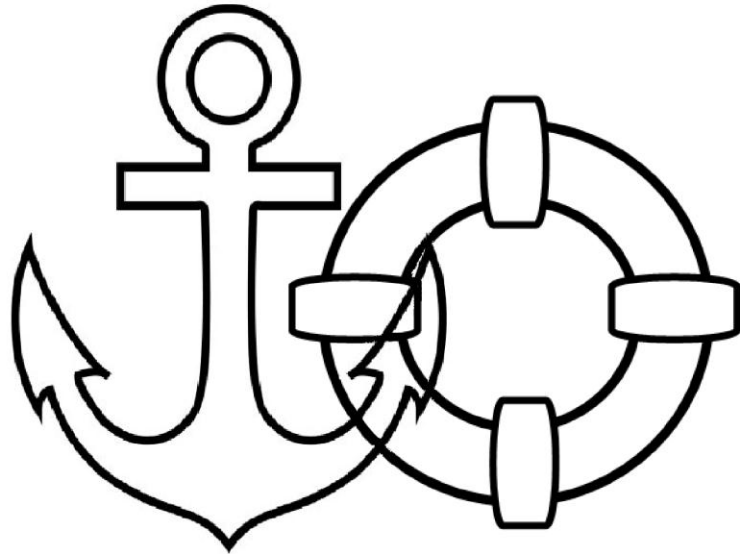

Sigue los laberintos y completa las oraciones

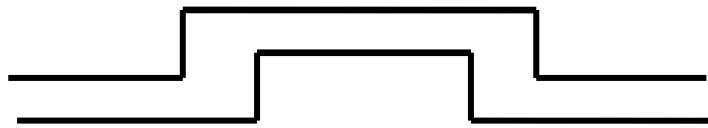

El marinero usa _____

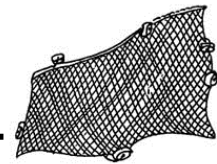
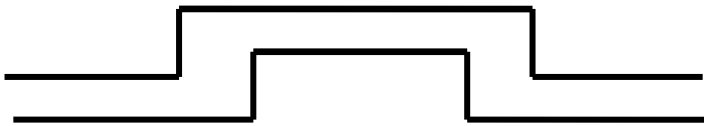

El marinero usa _____

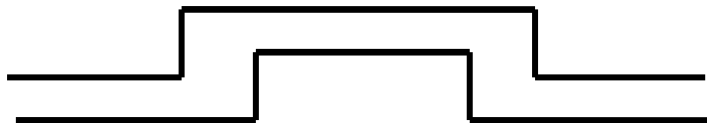

El marinero usa _____



EL PELUQUERO

El peluquero o la peluquera, trabaja en una peluquería. Corta y peina el pelo de las personas. Usa tijeras, peineta, cepillos, secador, alisador, tinturas y adornos para el pelo, entre otros.

Pinta las niñas que tienen el pelo corto



Pinta las niñas que tienen pelo largo

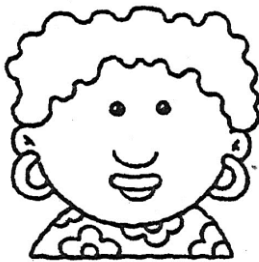

Dibuja tu corte de pelo y el de un familiar

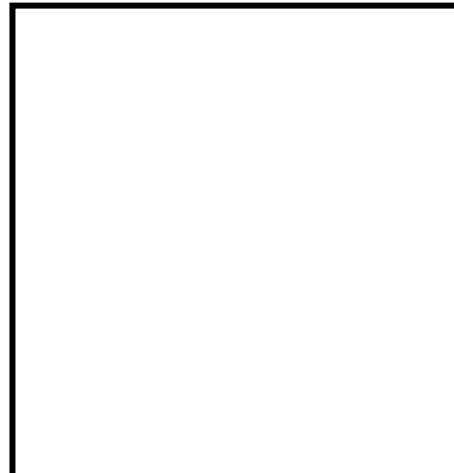
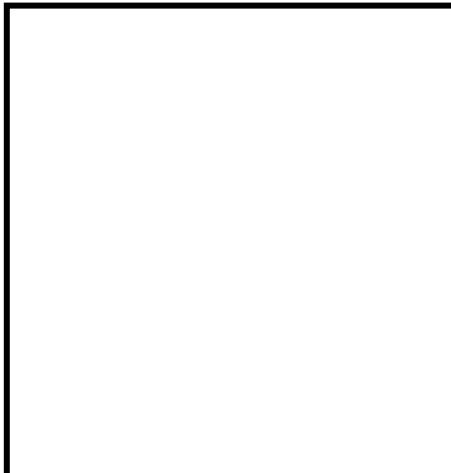



EL GRANJERO



¿Quién es? _____

¿Qué hace? _____

Dibuja el alimento que el granjero le da a sus animales. Pinta e imita como hacen estos animales de la granja



iiiiii

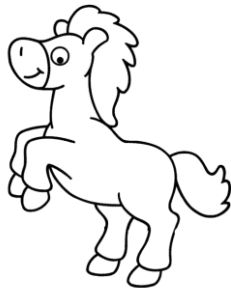

Oink oink



Cuak cuak

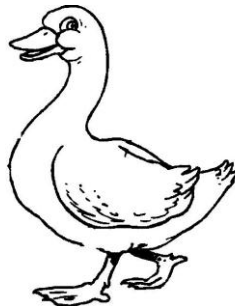

Coo coo cooo



Bee bee bee

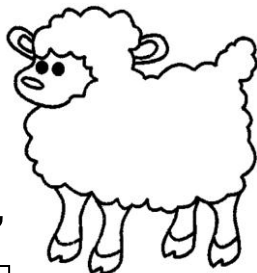

Muuu muuuu



El Cartero

El cartero trabaja en la oficina de correos y se encarga de entregar las cartas a todas las casas. Sigue el recorrido para que el cartero entregue las cartas y pinta.

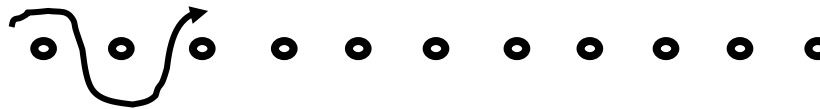
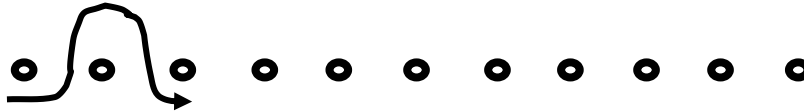
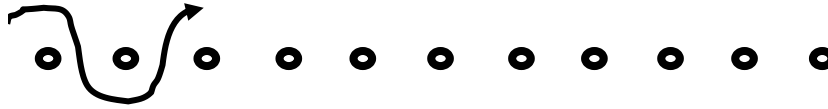

El Jardinero

El jardinero cuida las flores y los árboles de los jardines y parques. Los riega y los poda con mucho cuidado para que crezcan bonitos. Sigue el laberinto para que el jardinero llegue al árbol.

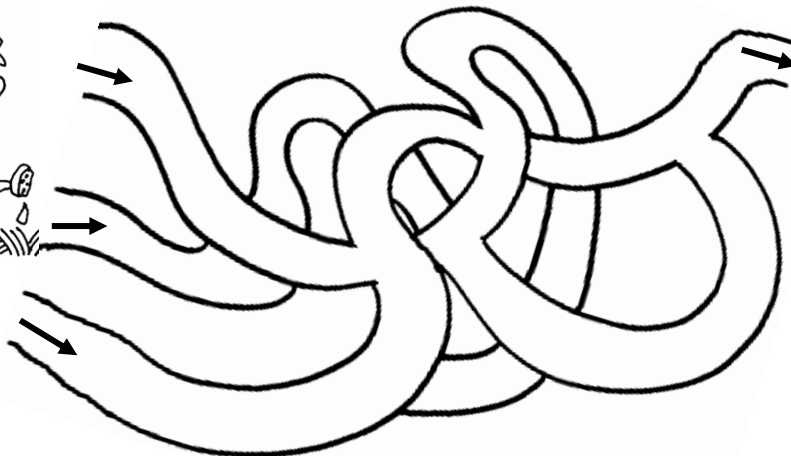



Pinta la cantidad de elementos que te indique el número

3



¿Quién usa la peineta en su trabajo?

5

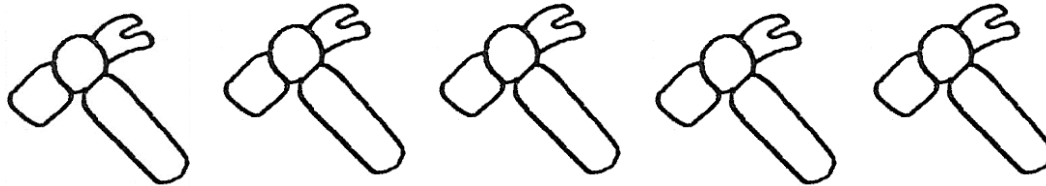

¿Quién usa el martillo en su trabajo?

4

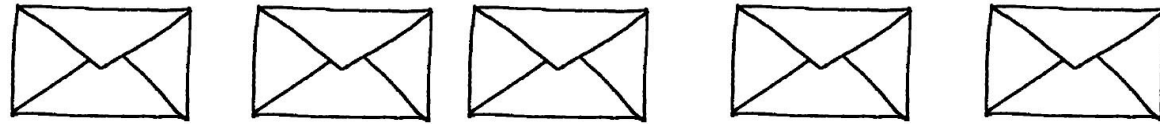

¿Quién usa cartas en su trabajo?



Cuenta y escribe el número:

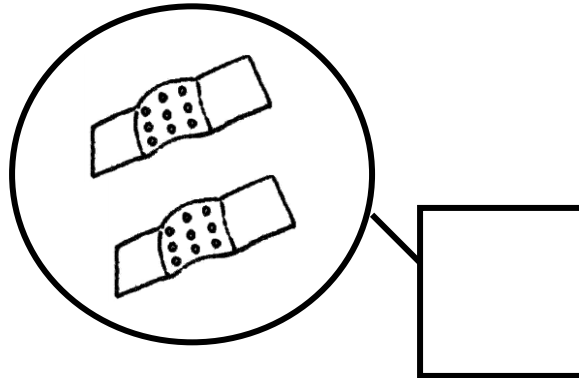
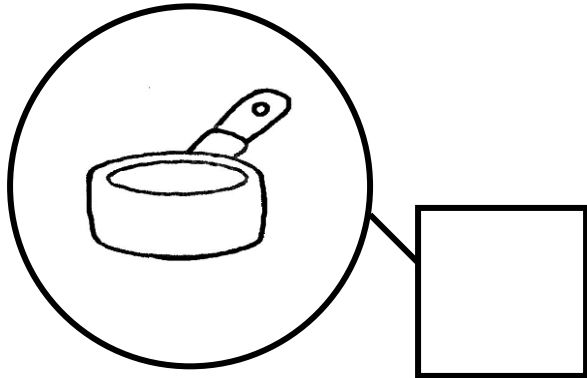

¿Quién usa sartén en su trabajo?

¿Quién usa parches en su trabajo?

¿Quién usa tijeras en su trabajo?

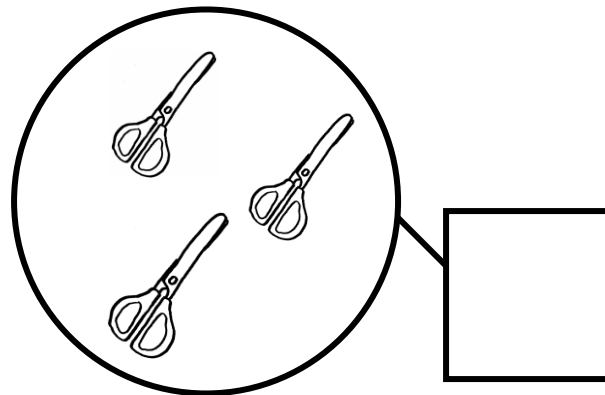



Actividades pedagógicas - Carolina Rebolledo Silva

